

NO. OF CONTACTS: 40,60,68,80,100,120
CRITERION PIN

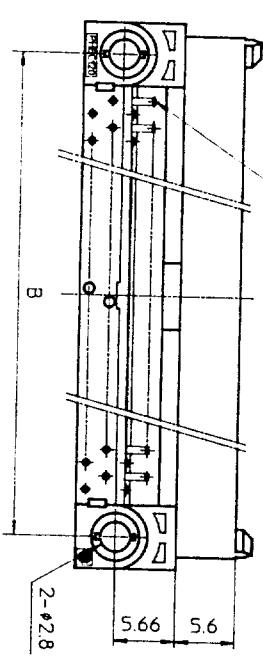

NO. OF CONTACTS: 30,34,50

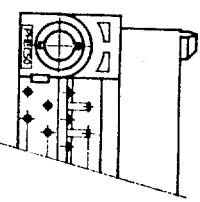

MATERIAL

BODY

LOCATOR

CONTACT

MOUNTING LATCH

SCREW NUT

STEEL

NICKEL PLATED

CAT. NO.	NO. OF CONTACTS (MATING SIDE)	DIMENSIONS				
		A	B	C	D	E
PHEC30P-R21	15/ROW X 2 ROWS	32.67	26.67	30.3	20.42	17.78
PHEC34P-R21	17/ROW X 2 ROWS	35.21	29.21	32.84	22.96	20.32
PHEC40P-R21	20/ROW X 2 ROWS	39.02	33.02	36.65	26.77	24.13
PHEC50P-R21	25/ROW X 2 ROWS	45.37	39.37	43	33.12	30.48
PHEC60P-R21	30/ROW X 2 ROWS	51.72	45.72	49.35	39.47	36.83
PHEC68P-R21	34/ROW X 2 ROWS	56.8	50.8	54.43	44.55	41.91
PHEC80P-R21	40/ROW X 2 ROWS	64.42	58.42	62.05	52.17	49.53
PHEC100P-R21	50/ROW X 2 ROWS	77.12	71.12	74.75	64.87	62.23
PHEC120P-R21	60/ROW X 2 ROWS	89.82	83.82	87.45	77.57	74.93

TOLERANCES
UNLESS OTHERWISE SPECIFIED: ±0.3

NOTE
THROUGH-HOLES FOR MOUNTING LATCHES ALSO SHOULD
BE PLATED.

CONTACT PLATING TABLE
(THICKNESS: μm)

CONTACT AREA	REMAINDER
GOLD 0.25 MIN. OVER NICKEL 3Z	SOLDER OVER NICKEL

DRAWING NO.
JSC 90736

PRINTED CIRCUIT CONNECTOR

CAT. NO.	PHEC___P-R21_
DRAWING NO.	JSC 90736
REV	3

BURNDY
JAPAN Ltd.

DESIGNED	
DRAWN	M. Oba
CHECKED	A. Ely
APPROVED	J. Koyashir
DATE	Mar. 8, 1990

SCALE	
DIM. IN	mm
MATERIAL	

REV	DATE	DESCRIPTION	CKD
3	'92-8-14	30,34,50,68 POSITIONS ADDED. LOCATOR MATERIAL ADDED.	
2	'90-6-7	EC 7866	
1	'90-4-20	EC 7837	

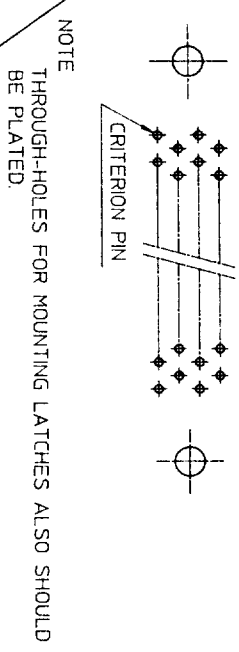
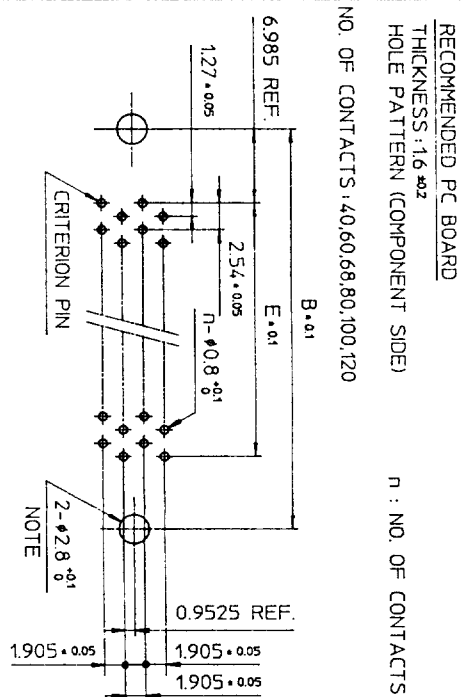
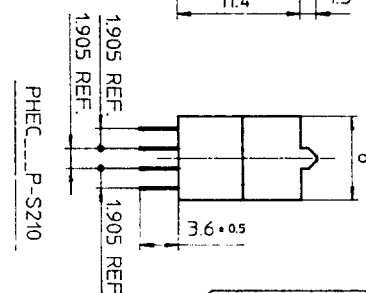
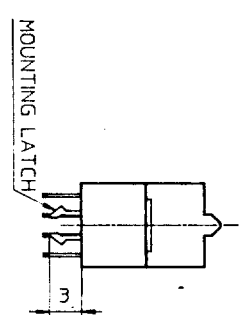
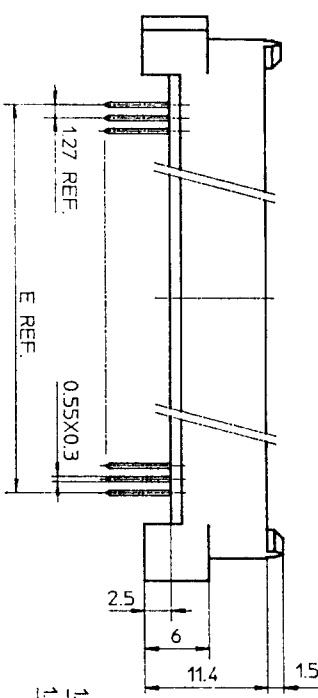
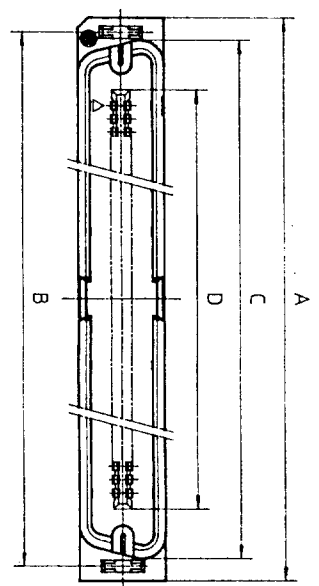

TOLERANCES UNLESS OTHERWISE SPECIFIED: ±0.3

NO. OF CONTACTS: 40,60,68,80,100,120

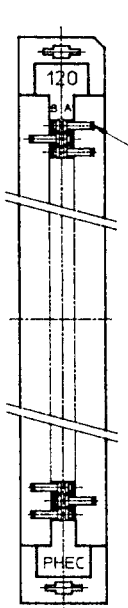

NO. OF CONTACTS: 30,34,50

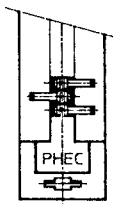

CAT. NO.	NO. OF CONTACTS (MATING SIDE)	DIMENSIONS				
		A	B	C	D	E
PHEC30P-S21	15/ROW X 2 ROWS	34.55	31.75	30.3	20.42	17.78
PHEC34P-S21	17/ROW X 2 ROWS	37.09	34.29	32.84	22.96	20.32
PHEC40P-S21	20/ROW X 2 ROWS	40.9	38.1	36.65	26.77	24.13
PHEC50P-S21	25/ROW X 2 ROWS	47.25	44.45	43	33.12	30.48
PHEC60P-S21	30/ROW X 2 ROWS	53.6	50.8	49.35	39.47	36.83
PHEC68P-S21	34/ROW X 2 ROWS	58.68	55.88	54.43	44.55	41.91
PHEC80P-S21	40/ROW X 2 ROWS	66.3	63.5	62.05	52.17	49.53
PHEC100P-S21	50/ROW X 2 ROWS	79.0	76.2	74.75	64.87	62.23
PHEC120P-S21	60/ROW X 2 ROWS	91.7	88.9	87.45	77.57	74.93

MATERIAL

INSULATOR: NYLON RESIN GLASS REINFORCED (UL94V-0)
COLOR: BLACK

CONTACT: COPPER ALLOY

MOUNTING LATCH: PHOSPHOR BRONZE
SOLDER PLATED

CONTACT PLATING TABLE

CONTACT AREA	REMAINDER
GOLD 0.25 MIN	SOLDER
OVER NICKEL 32	OVER NICKEL

PRINTED CIRCUIT CONNECTOR

CAT. NO.	PHEC__P-S21__
DRAWING NO.	JSC 90735
REV	3

BURNDY
JAPAN, Ltd.

DESIGNED	
DRAWN	M. Oba
CHECKED	A. Ch
APPROVED	J. Toyoshita
DATE	Mar. 8, 1990

SCALE	1:1
DIM IN	mm
MATERIAL	

REV	DATE	DESCRIPTION	CHK
3	8-11-92	30,34,50,68 POSITIONS ADDED.	
2	6-5-90	EC 7866	
1	4-20-90	EC 7837	

DRAWING NO
JSC 90735

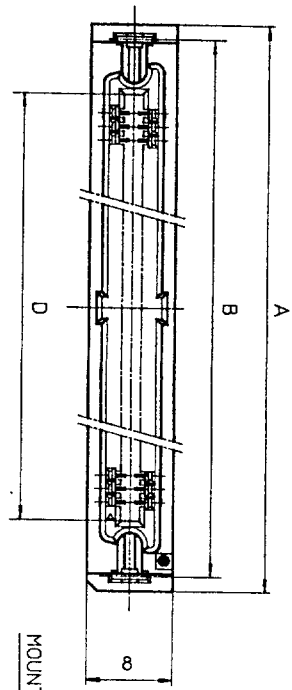

PHEC...R-S211

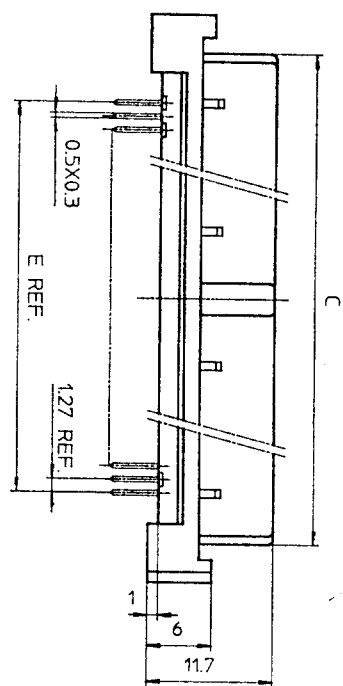

PHEC...R-S210

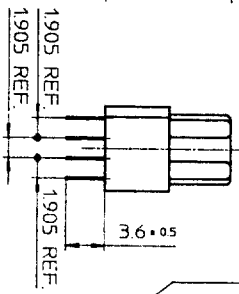

PHEC...R-S210

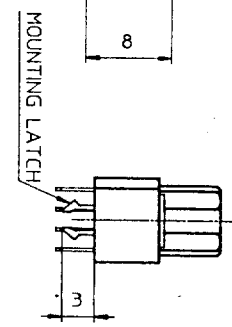

PHEC...R-S211

RECOMMENDED PC BOARD
 THICKNESS: 1.6 ± 0.2
 HOLE PATTERN (COMPONENT SIDE)
 NO. OF CONTACTS: 40,60,68,80,100,120
 n: NO. OF CONTACTS

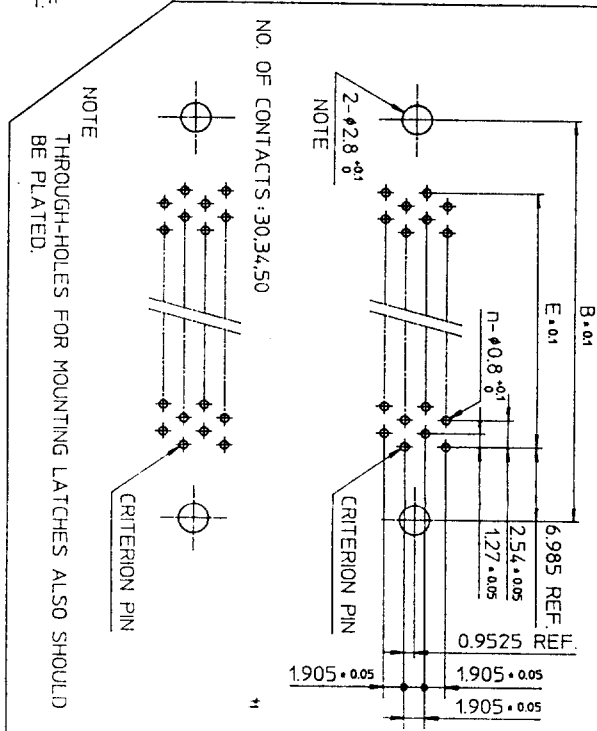

NOTE
 THROUGH-HOLES FOR MOUNTING LATCHES ALSO SHOULD BE PLATED.

TOLERANCES
 UNLESS OTHERWISE SPECIFIED: ±0.3

NO. OF CONTACTS: 40,60,68,80,100,120

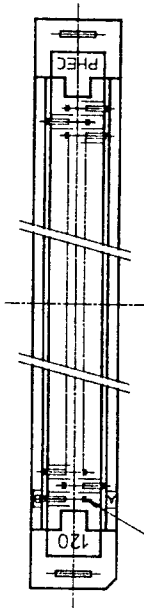

CRITERION PIN

NO. OF CONTACTS: 30,34,50

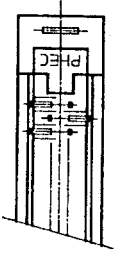

MATERIAL

INSULATOR: PBT RESIN GLASS REINFORCED (UL94V-0)
 COLOR: BLACK

CONTACT: PHOSPHOR BRONZE

MOUNTING LATCH: PHOSPHOR BRONZE
 SOLDER PLATED

CAT. NO.	NO. OF CONTACTS (MATING SIDE)	DIMENSIONS				
		A	B	C	D	E
PHEC30R-S21	15/ROW X 2 ROWS	34.55	31.75	27.26	21.26	17.78
PHEC34R-S21	17/ROW X 2 ROWS	37.09	34.29	29.8	23.8	20.32
PHEC40R-S21	20/ROW X 2 ROWS	40.9	38.1	33.61	27.61	24.13
PHEC50R-S21	25/ROW X 2 ROWS	47.25	44.45	39.96	33.96	30.48
PHEC60R-S21	30/ROW X 2 ROWS	53.6	50.8	46.31	40.31	36.83
PHEC68R-S21	34/ROW X 2 ROWS	58.68	55.88	51.39	45.39	41.91
PHEC80R-S21	40/ROW X 2 ROWS	66.3	63.5	59.01	53.01	49.53
PHEC100R-S21	50/ROW X 2 ROWS	79.0	76.2	71.71	65.71	62.23
PHEC120R-S21	60/ROW X 2 ROWS	91.7	88.9	84.41	78.41	74.93

CONTACT PLATING TABLE

(THICKNESS: μm)

CONTACT AREA	REMAINDER
GOLD 0.25 MIN. OVER NICKEL 3.2	SOLDER OVER NICKEL

DRAWING NO. JSC 90737

PRINTED CIRCUIT CONNECTOR
 CAT. NO. PHEC...R-S211
 DRAWING NO. JSC 90737
 REV. 4
BURNDY JAPAN Ltd.

DESIGNED
 DRAWN M. Oba
 CHECKED A. Ebi
 APPROVED J. Hasegawa
 DATE Mar. 8, 1990

SCALE
 DIM. IN mm
 MATERIAL

REV	DATE	DESCRIPTION	CKD
3	8-11-92	30,34,50,68 POSITIONS ADDED	no S.P
2	5-30-90	EC 7866	no JK
1	4-20-90	EC 7837	no JK

DRAWING NO.
JSC 90739

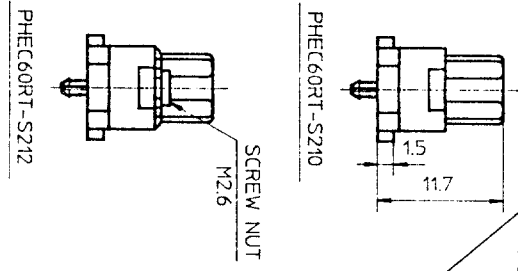
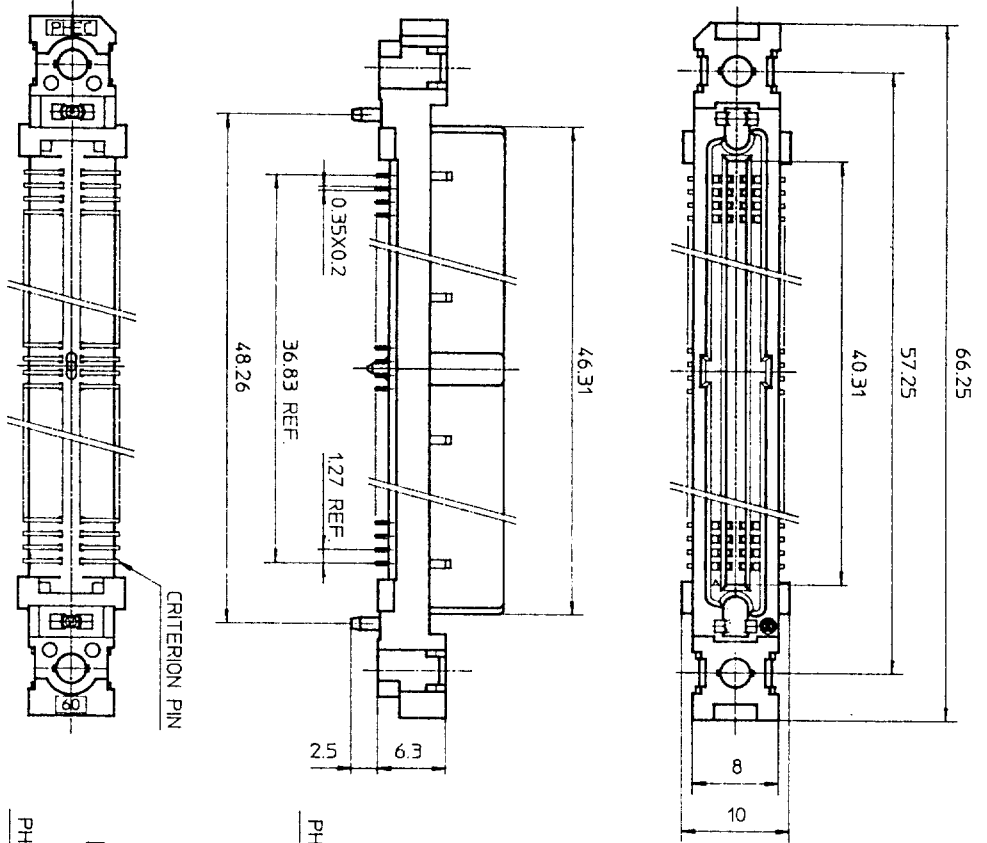

MATERIAL
INSULATOR : PPS RESIN GLASS REINFORCED (UL94V-0)
COLOR : BLACK
CONTACT : PHOSPHOR BRONZE
SCREW NUT : STAINLESS
NO. OF CONTACTS : 30/ROW X 2 ROWS (MATING SIDE)

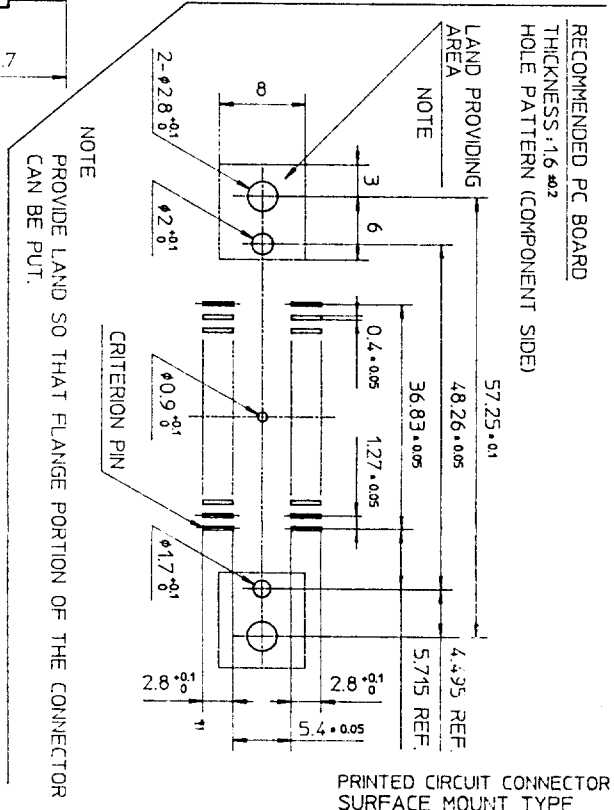

RECOMMENDED PC BOARD
THICKNESS : 1.6 ± 0.2
HOLE PATTERN (COMPONENT SIDE)

CONTACT PLATING TABLE
(THICKNESS : μm)

CONTACT AREA	REMAINDER
GOLD 0.25 MIN. OVER NICKEL 3.2	SOLDER OVER NICKEL

TOLERANCES
UNLESS OTHERWISE SPECIFIED : ±0.3

PRINTED CIRCUIT CONNECTOR
SURFACE MOUNT TYPE

REV	DATE	DESCRIPTION	CHKD.
4	'92 8-14	WRONG CONTACT DIM. CORRECTED 100 POSITIONS OF DELETED.	M.S.
3	'92 1-8	DIM. CHANGED.	JK
2	'90 6-8	EC7866	JK
1	'90 4-20	VARIATION ADDED.	JK

SCALE : 1/2
DIM IN : MM
MATERIAL :

DESIGNED :
DRAWN : M. Osa
CHECKED : A. Eb
APPROVED : J. Kobayashi
DATE : Mar. 8, 1990

CAT. NO. : PHEC60RT-S21_
DRAWING NO. : JSC 90739
REV : 4



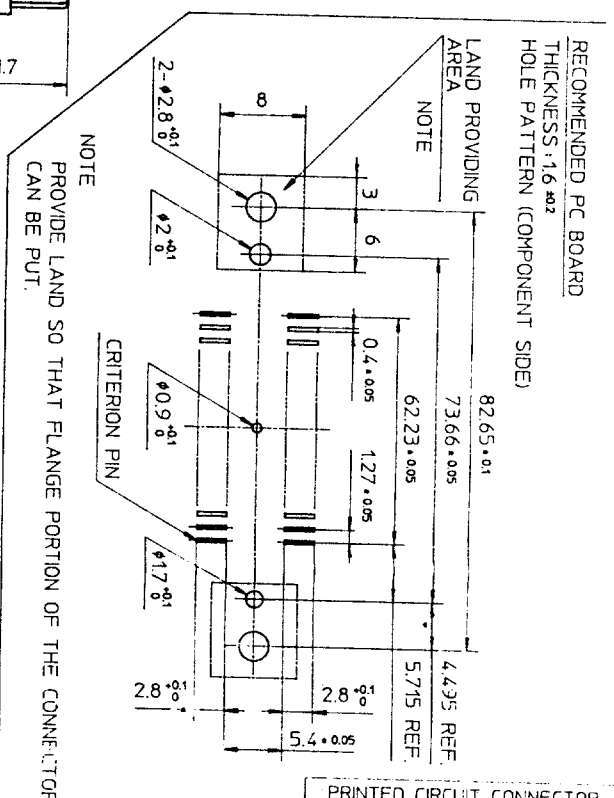
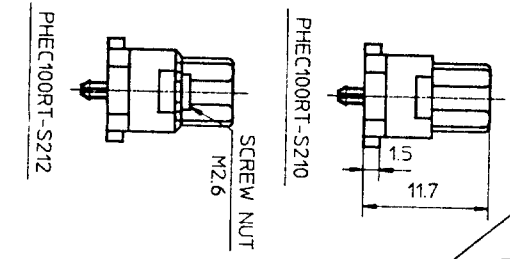
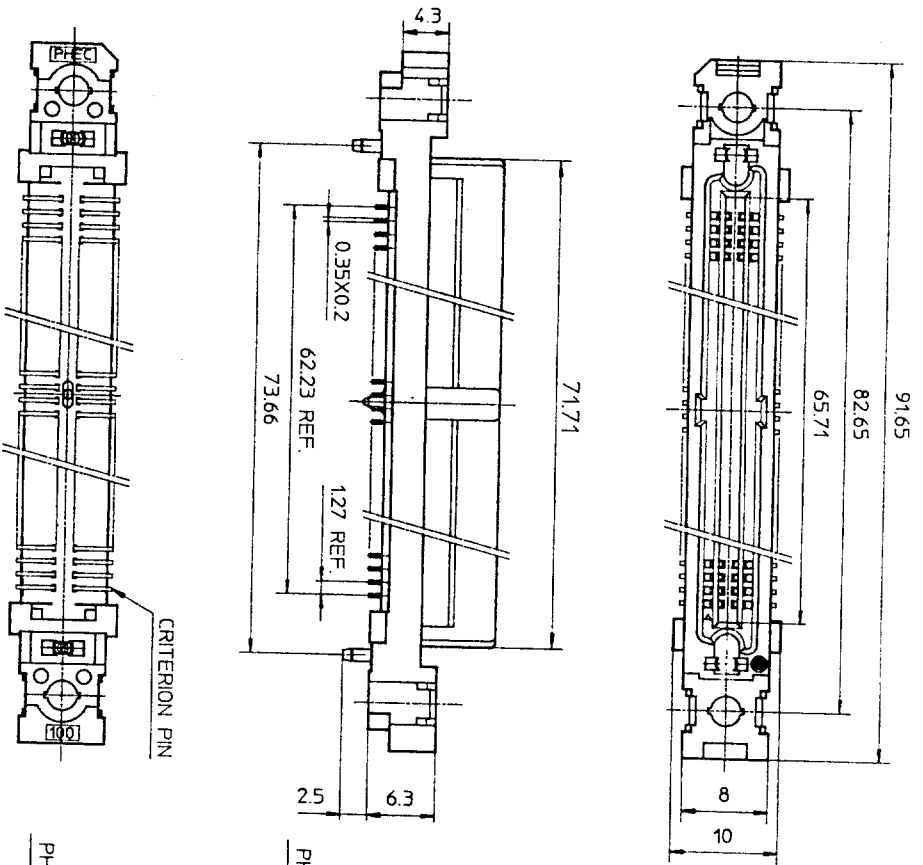

RECOMMENDED PC BOARD
 THICKNESS: 1.6 ± 0.2
 HOLE PATTERN (COMPONENT SIDE)

NOTE
 PROVIDE LAND SO THAT FLANGE PORTION OF THE CONNECTOR CAN BE PUT.

MATERIAL
 INSULATOR : PPS RESIN GLASS REINFORCED (UL94V-0)
 COLOR : BLACK
 CONTACT : PHOSPHOR BRONZE
 SCREW NUT : STAINLESS
 NO. OF CONTACTS : 50/ROW X 2 ROWS (MATING SIDE)

TOLERANCES
 UNLESS OTHERWISE SPECIFIED : ±0.3

CONTACT PLATING TABLE
 [THICKNESS : μm]

CONTACT AREA	REMAINDER
GOLD 0.25 MIN. OVER NICKEL 3Z	SOLDER OVER NICKEL

PRINTED CIRCUIT CONNECTOR
 SURFACE MOUNT TYPE

CAT. NO. PHEC100RT-S21

DRAWING NO. JSC 91839 REV. 0

BURNDY
 JAPAN, Ltd.

DESIGNED
 DRAWN
 CHECKED
 APPROVED
 DATE Aug. 11, 1992

SCALE
 DIM. IN
 MATERIAL

REV.	DATE	DESCRIPTION	CHKD.

DRAWING NO.
 JSC 91839

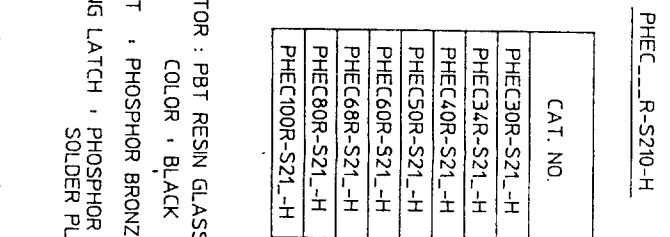
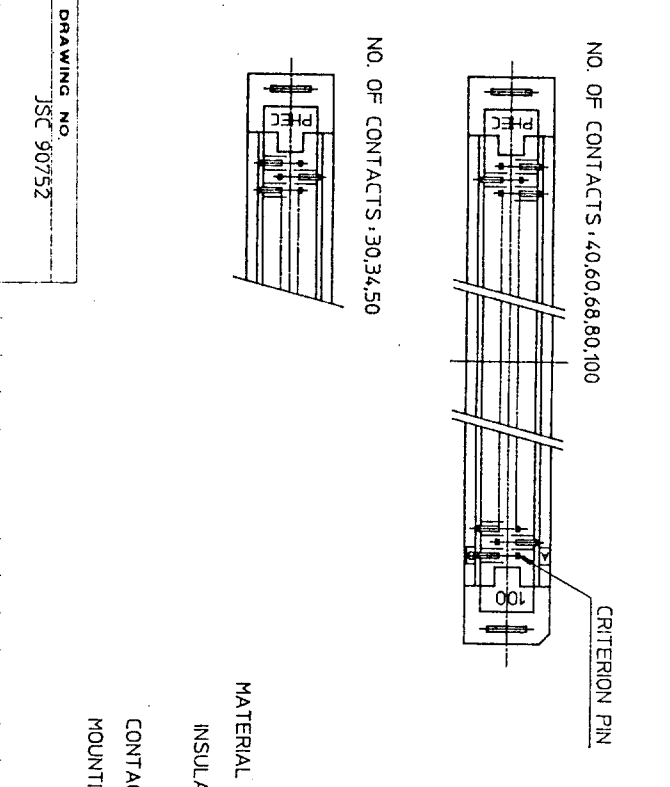

CAT. NO.	NO. OF CONTACTS (MATING SIDE)	DIMENSIONS				
		A	B	C	D	E
PHEC30R-S21-H	15/ROW X 2 ROWS	34.55	31.75	27.26	21.26	17.78
PHEC34R-S21-H	17/ROW X 2 ROWS	37.09	34.29	29.8	23.8	20.32
PHEC40R-S21-H	20/ROW X 2 ROWS	40.9	38.1	33.61	27.61	24.13
PHEC50R-S21-H	25/ROW X 2 ROWS	47.25	44.45	39.96	33.96	30.48
PHEC60R-S21-H	30/ROW X 2 ROWS	53.6	50.8	46.31	40.31	36.83
PHEC68R-S21-H	34/ROW X 2 ROWS	58.68	55.88	51.39	45.39	41.91
PHEC80R-S21-H	40/ROW X 2 ROWS	66.3	63.5	59.01	53.01	49.53
PHEC100R-S21-H	50/ROW X 2 ROWS	79.0	76.2	71.71	65.71	62.23

REV	DATE	DESCRIPTION	CKD.
5	'93 6-22	100 POSITIONS ADDED.	M. O
4	'93 2-1	WRONG CONTACT DIM. CORRECTED.	S. O
3	'92 8-11	100,120 POSITIONS DELETED. 30,34,50,68 POSITIONS ADDED.	S. O
2	'90 5-30	DIM. CHANGED (36.61 → 33.61)	J. K
1	'90 5-14	EC 7866	HE

DESIGNED	
DRAWN	M. Oba
CHECKED	
APPROVED	J. Ogasawara
DATE	Mar. 24, 1990

SCALE	1:1
DIM IN	mm
MATERIAL	

PRINTED CIRCUIT CONNECTOR HIGH STAND OFF TYPE
CAT. NO. PHEC__R-S21_-H
DRAWING NO. JSC 90752
REV 5
BURNDY JAPAN, Ltd.

RECOMMENDED PC BOARD
THICKNESS: 1.6 ± 0.2
HOLE PATTERN (COMPONENT SIDE)

NO. OF CONTACTS: 40,60,68,80,100

NO. OF CONTACTS: 30,34,50

INSULATOR: PBT RESIN GLASS REINFORCED (UL94V-0)
COLOR: BLACK

CONTACT: PHOSPHOR BRONZE
MOUNTING LATCH: PHOSPHOR BRONZE
SOLDER PLATED

MATERIAL

CONTACT PLATING TABLE
(THICKNESS: μm)

TOLERANCES UNLESS OTHERWISE SPECIFIED: ±0.3

NOTE
THROUGH-HOLES FOR MOUNTING LATCHES ALSO SHOULD BE PLATED.

DRAWING NO. JSC 90752

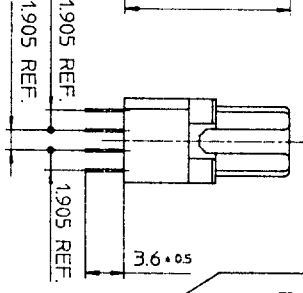
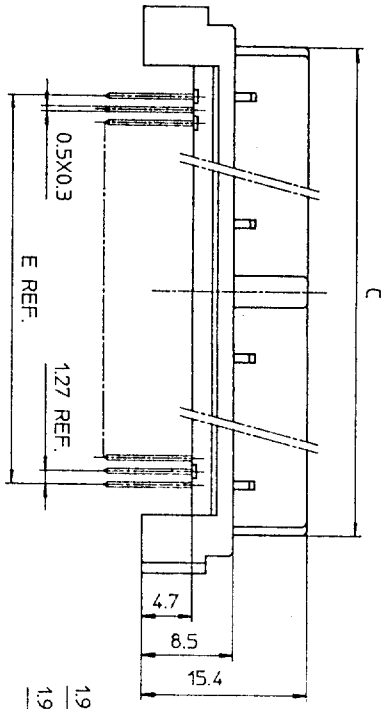
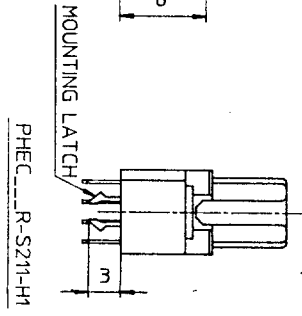
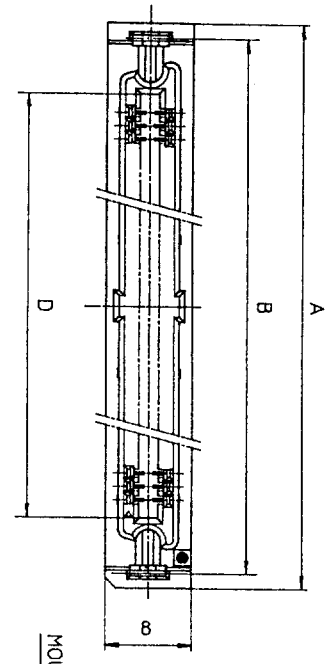

RECOMMENDED PC BOARD
THICKNESS: 1.6 ± 0.2
HOLE PATTERN (COMPONENT SIDE)
NO. OF CONTACTS: 40,60,68

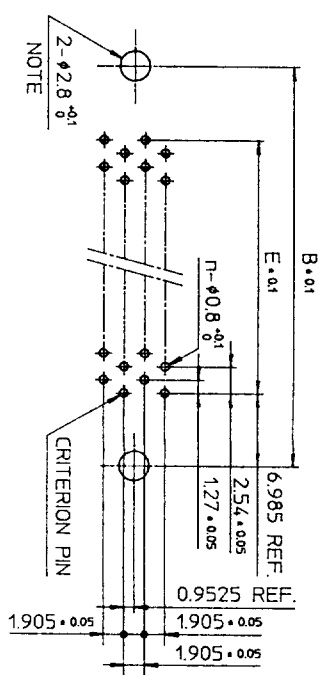

NO. OF CONTACTS: 30,34,50

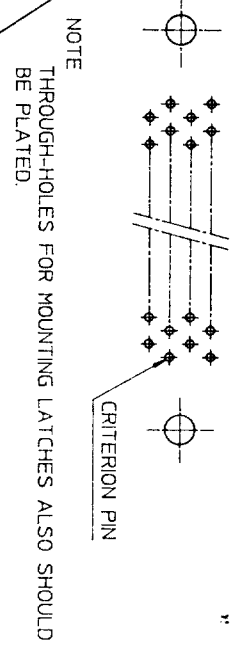

NO. OF CONTACTS: 40,60,68

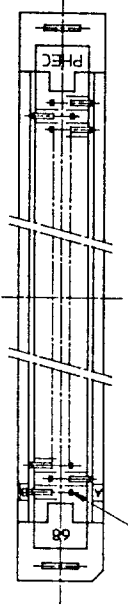

NO. OF CONTACTS: 30,34,50

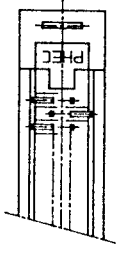

CAT. NO.	NO. OF CONTACTS (MATING SIDE)	DIMENSIONS				
		A	B	C	D	E
PHEC30R-S21-H1	15/ROW X 2 ROWS	34.55	31.75	27.26	21.26	17.78
PHEC34R-S21-H1	17/ROW X 2 ROWS	37.09	34.29	29.8	23.8	20.32
PHEC40R-S21-H1	20/ROW X 2 ROWS	40.9	38.1	33.61	27.61	24.13
PHEC50R-S21-H1	25/ROW X 2 ROWS	47.25	44.45	39.96	33.96	30.48
PHEC60R-S21-H1	30/ROW X 2 ROWS	53.6	50.8	46.31	40.31	36.83
PHEC68R-S21-H1	34/ROW X 2 ROWS	58.68	55.88	51.39	45.39	41.91

TOLERANCES
UNLESS OTHERWISE SPECIFIED: ±0.3

MATERIAL

INSULATOR: PBT RESIN GLASS REINFORCED (UL94V-0)

COLOR: BLACK

CONTACT: PHOSPHOR BRONZE

MOUNTING LATCH: PHOSPHOR BRONZE
SOLDER PLATED

CONTACT PLATING TABLE

CONTACT AREA	REMAINDER
GOLD 0.25 MIN. OVER NICKEL 3.2	SOLDER OVER NICKEL

DRAWING NO. JSC 91840

PRINTED CIRCUIT CONNECTOR
HIGH STAND OFF TYPE
CAT. NO. PHEC_R-S21-H1
DRAWING NO. JSC 91840
REV. 1

BURNDY
JAPAN, Ltd.

DESIGNED
DRAWN *M. Oba*
CHECKED A. matsuo
APPROVED *S. Ito*
DATE Aug. 17, 1992

SCALE
DIM IN mm
MATERIAL

REV. DATE	DESCRIPTION	CKD
1 93	WRONG CONTACT DIM. CORRECTED.	
2-1		

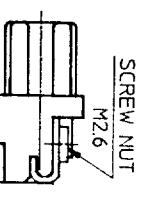
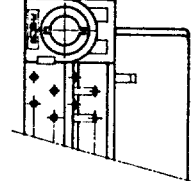
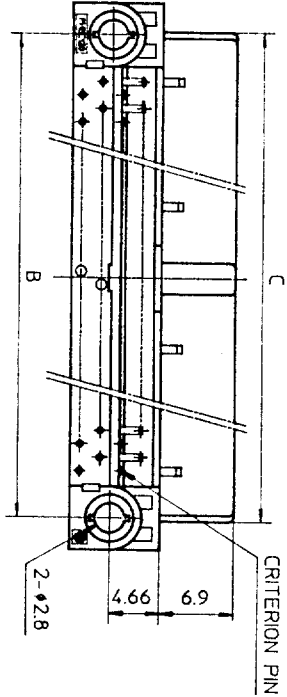
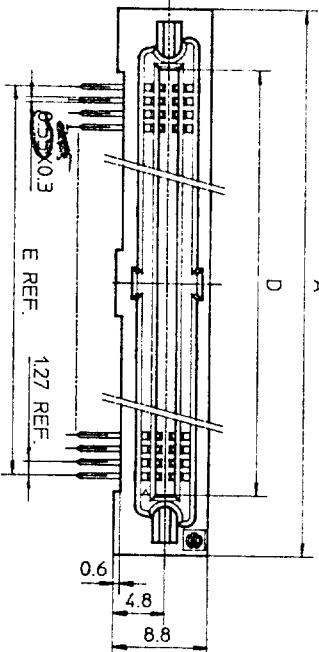
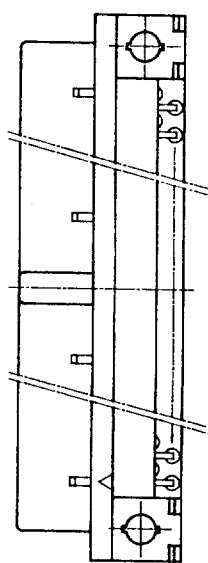

SCREW NUT
M2.6

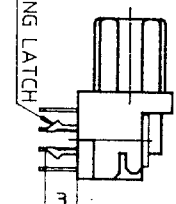

MOUNTING LATCH
PHEC...R-R211

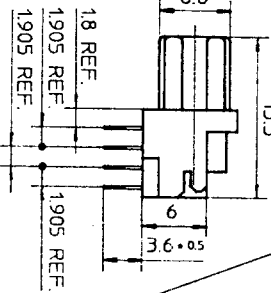

CRITERION PIN
PHEC...R-R210

RECOMMENDED P.C. BOARD
THICKNESS: 1.6^{+0.2}
HOLE PATTERN (COMPONENT SIDE)
NO. OF CONTACTS: 40, 60, 68, 80,
100, 120

n : NO. OF CONTACTS

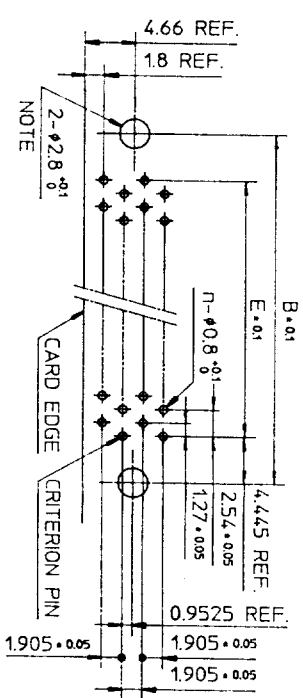

NO. OF CONTACTS: 30, 34, 50

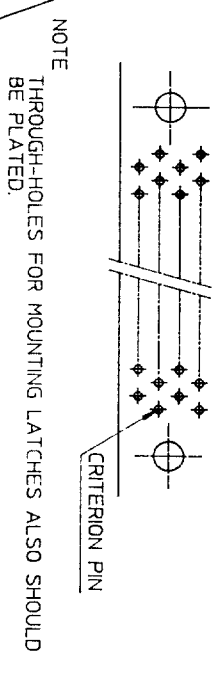

NOTE
THROUGH-HOLES FOR MOUNTING LATCHES ALSO SHOULD
BE PLATED.

TOLERANCES
UNLESS OTHERWISE SPECIFIED: ±0.3

NO. OF CONTACTS: 30, 34, 50

MATERIAL

- BODY : PBT RESIN GLASS REINFORCED (UL94V-0)
- LOCATOR COLOR : BLACK
- CONTACT : PHOSPHOR BRONZE
- MOUNTING LATCH : PHOSPHOR BRONZE
SOLDER PLATED
- SCREW NUT : STEEL
NICKEL PLATED

CAT. NO.	NO. OF CONTACTS (MATING SIDE)	DIMENSIONS				
		A	B	C	D	E
PHEC30R-R21	15/ROW X 2 ROWS	32.67	26.67	27.26	21.26	17.78
PHEC34R-R21	17/ROW X 2 ROWS	35.21	29.21	29.8	23.8	20.32
PHEC40R-R21	20/ROW X 2 ROWS	39.02	33.02	33.61	27.61	24.13
PHEC50R-R21	25/ROW X 2 ROWS	45.37	39.37	39.96	33.96	30.48
PHEC60R-R21	30/ROW X 2 ROWS	51.72	45.72	46.31	40.31	36.83
PHEC68R-R21	34/ROW X 2 ROWS	56.8	50.8	51.39	45.39	41.91
PHEC80R-R21	40/ROW X 2 ROWS	64.42	58.42	59.01	53.01	49.53
PHEC100R-R21	50/ROW X 2 ROWS	77.12	71.12	71.71	65.71	62.23
PHEC120R-R21	60/ROW X 2 ROWS	89.82	83.82	84.41	78.41	74.93

CONTACT PLATING TABLE
(THICKNESS: μm)

CONTACT AREA	REMAINDER
GOLD 0.25 MIN. OVER NICKEL 3.2	SOLDER OVER NICKEL

DRAWING NO.
JSC 90738

PRINTED CIRCUIT CONNECTOR
CAT. NO. PHEC...R-R21
DRAWING NO. JSC 90738
REV. 3
BURNDY JAPAN, Ltd.

DESIGNED
DRAWN *M. Oba*
CHECKED *A. Oba*
APPROVED *T. Ogasawara*
DATE Mar. 8, 1990

SCALE
DIM. IN mm
MATERIAL

REV.	DATE	DESCRIPTION	CKD
3	92-8-11	30, 34, 50, 68 POSITIONS ADDED.	<i>M. Oba</i>
2	90-6-8	EC 7866	<i>No</i>
1	90-4-20	EC 7837	<i>No</i>